

# Miniature Glass Passivated Fast Recovery Surface Mount Bridge Rectifier

## MB2S, MB4S, MB6S Vishaymas General Semiconductor

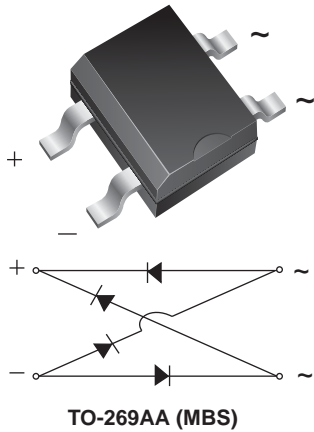

### FEATURES

- UL recognition, file number E54214
- Saves space on printed circuit boards
- Ideal for automated placement
- High surge current capability
- Meets MSL level 1, per J-STD-020, LF maximum peak of 260 °C
- Material categorization: For definitions of compliance please see [www.vishaymas.com](http://www.vishaymas.com)

### TYPICAL APPLICATIONS

General purpose use in AC/DC bridge full wave rectification for power supply, lighting ballaster, battery charger, home appliances, office equipment, and telecommunication applications.

PRIMARY CHARACTERISTICS	
Package	TO-269AA (MBS)
$I_{F(AV)}$	0.5 A
$V_{RRM}$	200 V, 400 V, 600 V
$I_{FSM}$	35 A
$I_R$	5 $\mu$ A
$V_F$ at $I_F = 0.4$ A	1.0 V
$T_J$ max.	150 °C
Diode variations	Quad

### MECHANICAL DATA

**Case:** TO-269AA (MBS)

Molding compound meets UL 94 V-0 flammability rating  
 Base P/N-E3 - RoHS-compliant, commercial grade

**Terminals:** Matte tin plated leads, solderable per J-STD-002 and JESD22-B102

E3 suffix meets JESD 201 class 1A whisker test

**Polarity:** As marked on body

MAXIMUM RATINGS ( $T_A = 25$ °C unless otherwise noted)					
PARAMETER	SYMBOL	MB2S	MB4S	MB6S	UNIT
Device marking code		2	4	6	
Maximum repetitive peak reverse voltage	$V_{RRM}$	200	400	600	V
Maximum RMS voltage	$V_{RMS}$	140	280	420	V
Maximum DC blocking voltage	$V_{DC}$	200	400	600	V
Maximum average forward output rectified current (fig. 1)	$I_{F(AV)}$	on glass-epoxy PCB <sup>(1)</sup>		0.5	A
		on aluminum substrate <sup>(2)</sup>		0.8	
Peak forward surge current 8.3 ms single half sine-wave superimposed on rated load	$I_{FSM}$	35			A
Rating for fusing ( $t < 8.3$ ms)	$I^2t$	5.0			A <sup>2</sup> s
Operating junction and storage temperature range	$T_J, T_{STG}$	- 55 to + 150			°C

#### Notes

<sup>(1)</sup> On glass epoxy PCB mounted on 0.05" x 0.05" (1.3 mm x 1.3 mm) pads

<sup>(2)</sup> On aluminum substrate PCB with an area of 0.8" x 0.8" (20 mm x 20 mm) mounted on 0.05" x 0.05" (1.3 mm x 1.3 mm) solder pad

ELECTRICAL CHARACTERISTICS ( $T_A = 25\text{ }^\circ\text{C}$ unless otherwise noted)						
PARAMETER	TEST CONDITIONS	SYMBOL	MB2S	MB4S	MB6S	UNIT
Maximum instantaneous forward voltage per diode	$I_F = 0.4\text{ A}$	$V_F$		1.0		V
Maximum DC reverse current at rated DC blocking voltage per diode	$T_A = 25\text{ }^\circ\text{C}$	$I_R$		5.0		$\mu\text{A}$
	$T_A = 125\text{ }^\circ\text{C}$			100		
Typical junction capacitance per diode	4.0 V, 1 MHz	$C_J$		13		pF

THERMAL CHARACTERISTICS ( $T_A = 25\text{ }^\circ\text{C}$ unless otherwise noted)					
PARAMETER	SYMBOL	MB2S	MB4S	MB6S	UNIT
Typical thermal resistance	$R_{\theta JA}^{(1)}$		85		$^\circ\text{C/W}$
	$R_{\theta JA}^{(2)}$		70		
	$R_{\theta JL}^{(1)}$		20		

**Notes**

- (1) On glass epoxy PCB mounted on 0.05" x 0.05" (1.3 mm x 1.3 mm) pads
- (2) On aluminum substrate PCB with an area of 0.8" x 0.8" (20 mm x 20 mm) mounted on 0.05" x 0.05" (1.3 mm x 1.3 mm) solder pad

ORDERING INFORMATION (Example)				
PREFERRED P/N	UNIT WEIGHT (g)	PREFERRED PACKAGE CODE	BASE QUANTITY	DELIVERY MODE
MB2S-E3/45	0.22	45	100	Tube
MB2S-E3/80	0.22	80	3000	13" diameter paper tape and reel

**RATINGS AND CHARACTERISTICS CURVES ( $T_A = 25\text{ }^\circ\text{C}$  unless otherwise noted)**

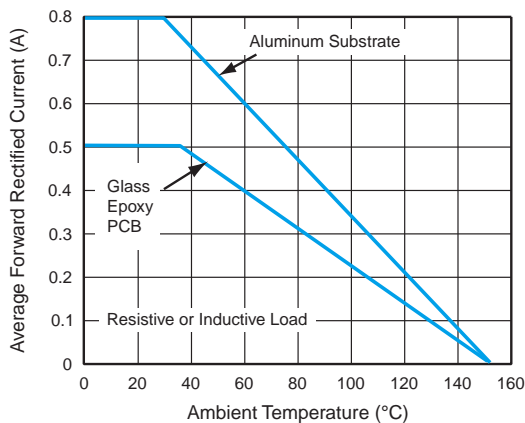

Fig. 1 - Derating Curve for Output Rectified Current

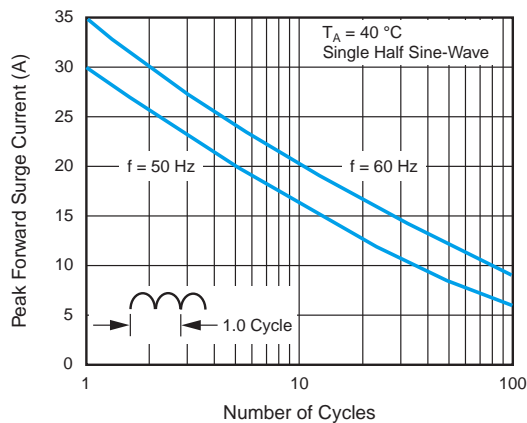

Fig. 2 - Maximum Non-Repetitive Peak Forward Surge Current Per Diode

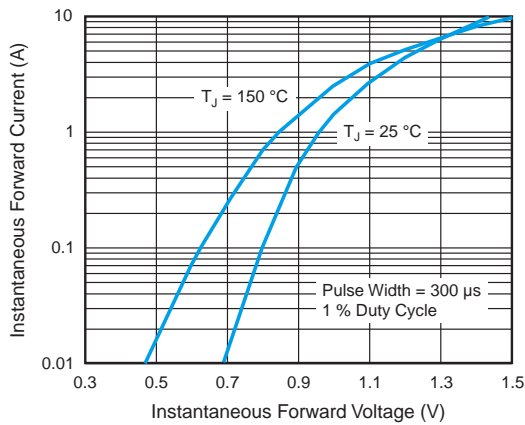

Fig. 3 - Typical Forward Voltage Characteristics Per Diode

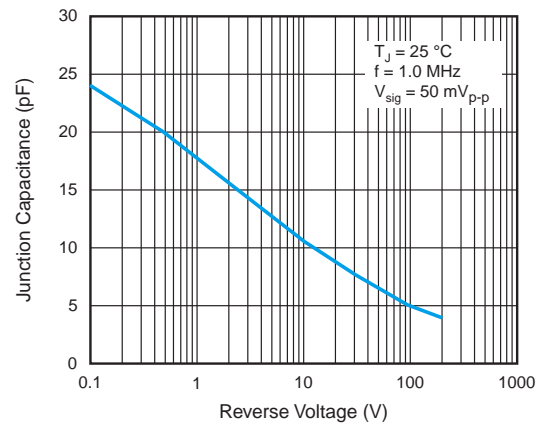

Fig. 5 - Typical Junction Capacitance Per Diode

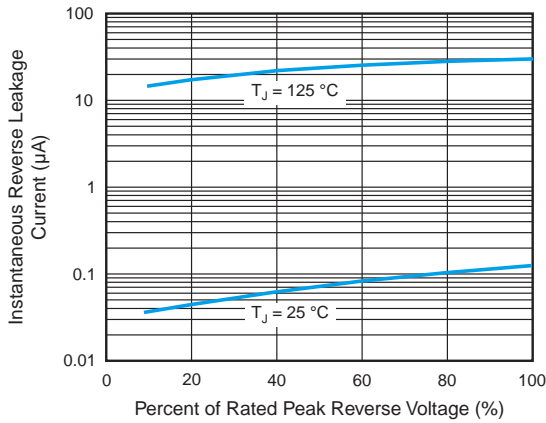
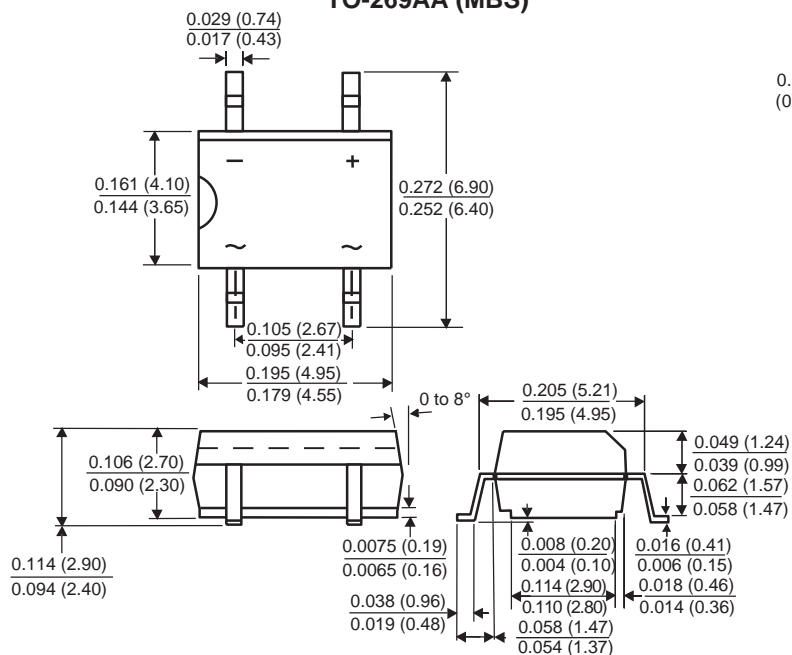

Fig. 4 - Typical Reverse Leakage Characteristics Per Diode

**PACKAGE OUTLINE DIMENSIONS** in inches (millimeters)

**TO-269AA (MBS)**



**Mounting Pad Layout**

